

600V N-Channel MOSFET

Features

- 4.5A,600v,RDS(on)=2.2Ω@VGS=10V
- Gate charge (Typical 17nC)
- High ruggedness
- Fast switching
- 100% AvalancheTested
- Improved dv/dt capability

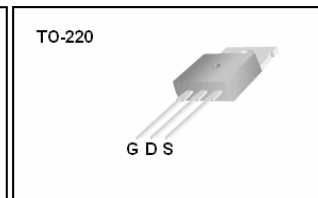
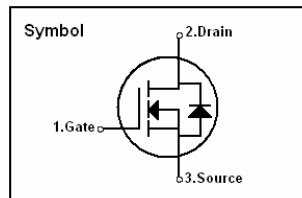

General Description

This Power MOSFET is produced using Truesemi's advanced planar stripe, DMOS technology. This latest technology has been especially designed to minimize on-state resistance, have a high rugged avalanche characteristics, such as fast switching time, low on resistance, low gate charge and especially excellent avalanche characteristics. This power MOSFET is usually used at AC adaptors, on the battery charger and SMPS

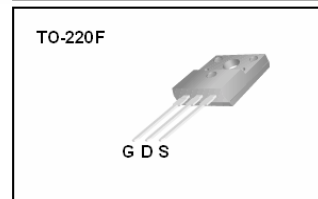

Absolute Maximum Ratings

Symbol	Parameter	TSP5N60M	TSF5N60M	Units
VDSS	Drain to Source Voltage	600		V
ID	Continuous Drain Current(@TC = 25°C)	4.5	4.5*	A
	Continuous Drain Current(@TC = 100°C)	2.7	2.7*	A
IDM	Drain Current Pulsed (Note 1)	18	18*	A
VGS	Gate to Source Voltage	±30		V
EAS	Single Pulsed Avalanche Energy (Note 2)	280		mJ
EAR	Repetitive Avalanche Energy (Note 1)	13		mJ
dv/dt	Peak Diode Recovery dv/dt (Note 3)	4.5		V/ns
PD	Total Power Dissipation(@TC = 25 °C)	120	45	W
	Derating Factor above 25 °C	0.8	0.5	W/ °C
TSTG, TJ	Operating Junction Temperature & Storage Temperature	-55 ~ 150		°C
TL	Maximum Lead Temperature for soldering purpose, 1/8 from Case for 5 seconds.	300		°C

Thermal Characteristics

Symbol	Parameter	TSP5N60M	TSF5N60M	Units
RθJC	Thermal Resistance, Junction-to-Case	1.25	3.79	°C/W
RθCS	Thermal Resistance, Case-to-Sink Typ	0.5	0.5	°C/W
RθJA	Thermal Resistance, Junction-to-Ambient	62.5	62.5	°C/W

TSP5N60M/TSF5N60M

Electrical Characteristics (TC = 25 °C unless otherwise noted)

Symbol	Parameter	Test Conditions	Min	Typ	Max	Units
Off Characteristics						
BVDSS	Drain-Source Breakdown Voltage	VGS = 0V, ID = 250uA	600	--	--	V
$\Delta BVDSS / \Delta T_J$	Breakdown Voltage Temperature coefficient	ID = 250uA, referenced to 25 °C	--	0.4	--	V/°C
IDSS	Drain-Source Leakage Current	VDS = 600V, VGS = 0V	--	--	10	uA
		VDS = 480V, TC = 125 °C	--	--	100	uA
IGSS	Gate-Source Leakage, Forward	VGS = 30V, VDS = 0V	--	--	100	nA
	Gate-source Leakage, Reverse	VGS = -30V, VDS = 0V	--	--	-100	nA
On Characteristics						
VGS(th)	Gate Threshold Voltage	VDS = VGS, ID = 250uA	2.0	--	4.0	V
RDS(ON)	Static Drain-Source On-state Resistance	VGS = 10 V, ID = 2.25A	--	2.0	2.2	Ω
Dynamic Characteristics						
Ciss	Input Capacitance	VGS = 0 V, VDS = 25V, f = 1MHz	--	545	780	pF
Coss	Output Capacitance		--	60	80	
Crss	Reverse Transfer Capacitance		--	8	11	
Dynamic Characteristics						
td(on)	Turn-on Delay Time	VDD = 300V, ID = 4.5A, RG = 25 Ω (Note 4, 5)	--	10	30	ns
tr	Rise Time		--	35	80	
td(off)	Turn-off Delay Time		--	45	100	
tf	Fall Time		--	40	90	
Qg	Total Gate Charge	VDS = 480V, VGS = 10V, ID = 4.5A (Note 4, 5)	--	17	--	nC
Qgs	Gate-Source Charge		--	2.8	--	
Qgd	Gate-Drain Charge(Miller Charge)		--	6.2	--	

Source-Drain Diode Ratings and Characteristics

Symbol	Parameter	Test Conditions	Min.	Typ.	Max.	Unit.
IS	Continuous Source Current	Integral Reverse p-n Junction	--	--	4.5	A
ISM	Pulsed Source Current	Diode in the MOSFET	--	--	18	
VSD	Diode Forward Voltage	IS=4.5A, VGS =0V	--	--	1.4	V
trr	Reverse Recovery Time	IS=4.5A, VGS=0V, dI/dt=100A/us	--	300	--	ns
Qrr	Reverse Recovery Charge	IS=4.5A, VGS=0V, dI/dt=100A/us	--	2.2	--	uC

※ NOTES

1. Repeatability rating : pulse width limited by junction temperature
2. L = 25.0mH, IAS = 4.5A, VDD = 50V, RG = 25 Ω , Starting TJ = 25°C
3. ISD \leq 4.5A, di/dt \leq 200A/us, VDD \leq BVDSS, Starting TJ = 25°C
4. Pulse Test : Pulse Width \leq 300us, Duty Cycle \leq 2%
5. Essentially independent of operating temperature



TSP5N60M/TSF5N60M

Fig 1. On-State Characteristics

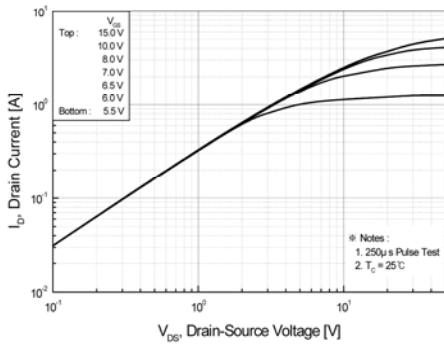

Fig 2. Transfer Characteristics

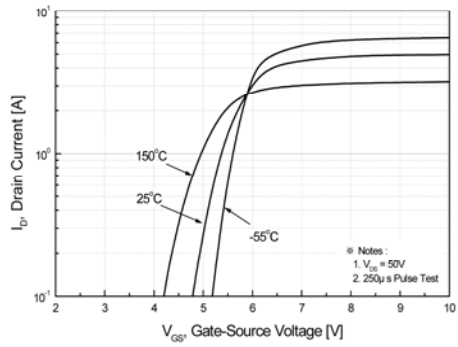

Fig 3. On Resistance Variation vs. Drain Current and Gate Voltage

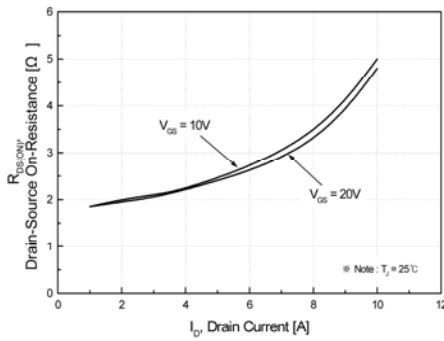

Fig 4. On State Current vs. Allowable Case Temperature

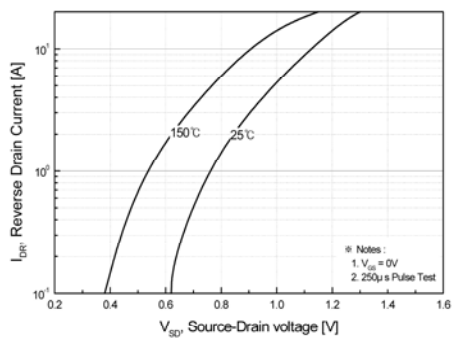

Fig 5. Capacitance Characteristics (Non-Repetitive)

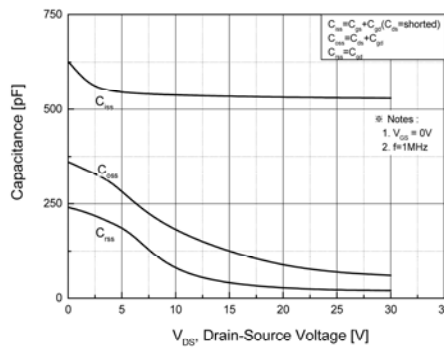
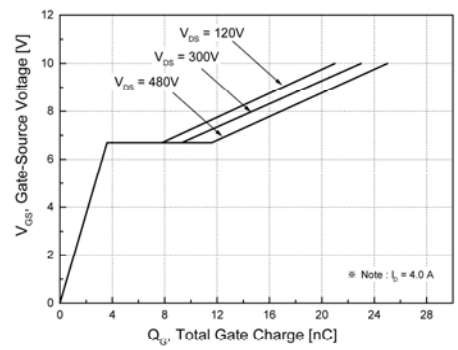

Fig 6. Gate Charge Characteristics



TSP5N60M/TSF5N60M

Fig 7. Breakdown Voltage Variation vs. Junction Temperature

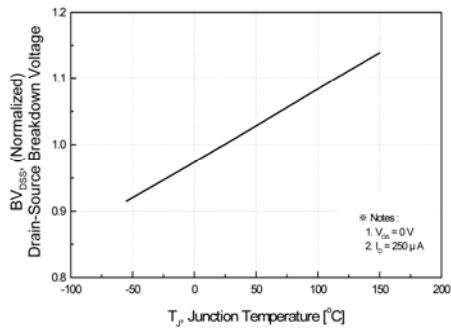

Fig 8. On-Resistance Variation vs. Junction Temperature

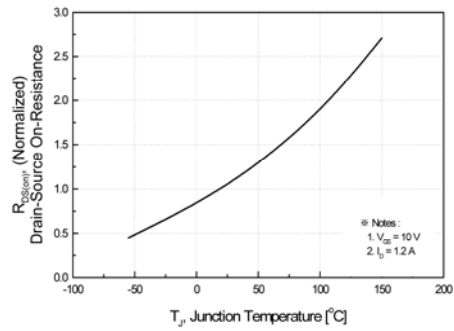

Fig 9-1. Maximum Safe Operating Area for TSP5N60M

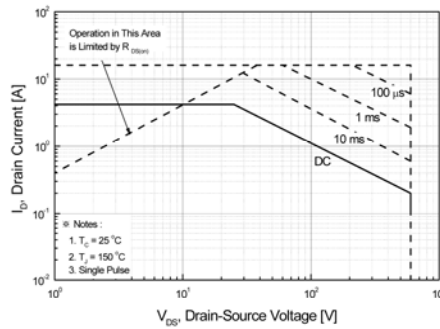

Fig 9-2. Maximum Safe Operating Area for TSF5N60M

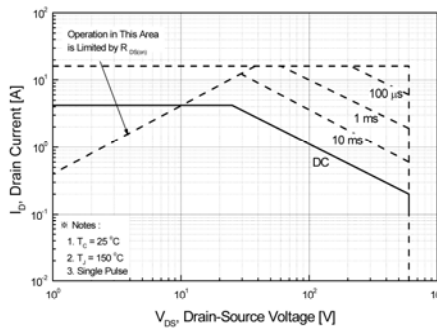
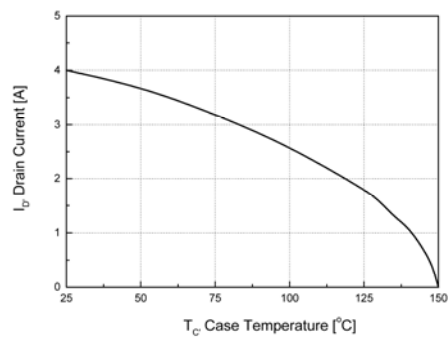

Fig 10. Maximum Drain Current vs. Case Temperature



TSP5N60M/TSF5N60M

Fig 11-1 . Transient Thermal Response Curve for TSP5N60M

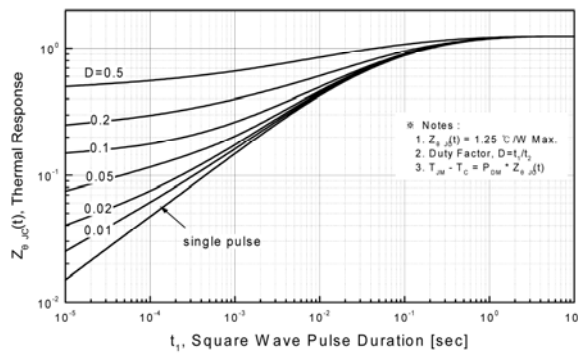
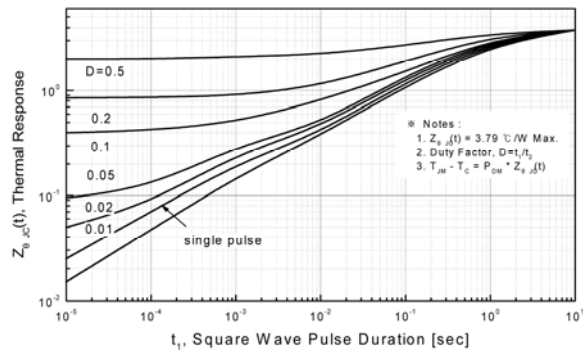

Fig 11-2 . Transient Thermal Response Curve for TSF5N60M



TSP5N60M/TSF5N60M

Fig. 12. Gate Charge Test Circuit & Waveforms

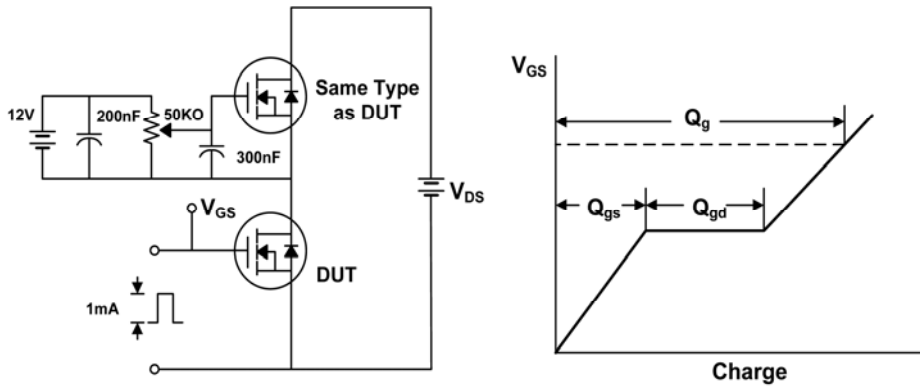

Fig. 13. Switching Time Test Circuit & Waveforms

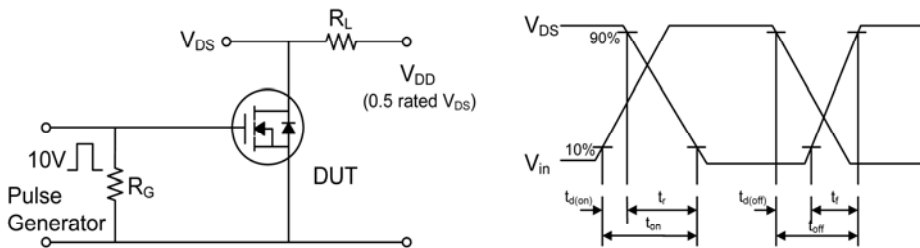
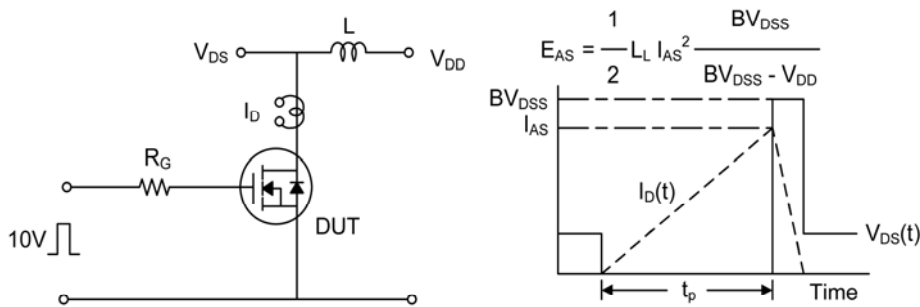

Fig. 14. Unclamped Inductive Switching Test Circuit & Waveforms



TSP5N60M/TSF5N60M

Fig. 15. Peak Diode Recovery dv/dt Test Circuit & Waveforms

